

**TECHNICAL SPECIFICATION / TECHNISCHE BESCHREIBUNG / DESCRIPTION TECHNIQUE**

**DESKS AND TABLES / SCHREIBTISCH UND TISCH / BUREAUX ET TABLES DE REUNION**

**Worktop  
Arbeitsplatte  
Plan de travail**

MFC / Melaminplatte /  
Panneau mélaminé  
52mm (12+12+28mm)

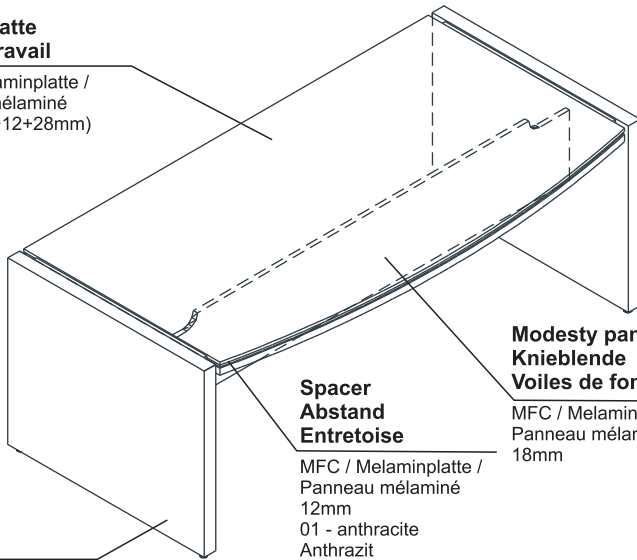

**Spacer  
Abstand  
Entretoise**

MFC / Melaminplatte /  
Panneau mélaminé  
12mm  
01 - anthracite  
Anthraxit  
anthracite

**Modesty panel  
Knieblende  
Voiles de fond structurel**

MFC / Melaminplatte /  
Panneau mélaminé  
18mm

**Base  
Gestell  
Piétement**

panel ends made of MFC 52mm  
Wangenfüße - Melaminplatte 52mm  
piétement Panneau mélaminé ép. 52mm

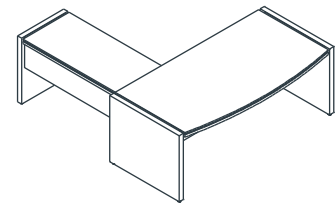
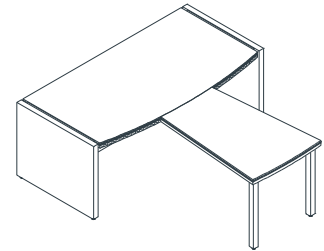

**Mediaport in option / Mediaport in Option / Mediaport en option**

pivotable / Steckdose drehbar / pivotable

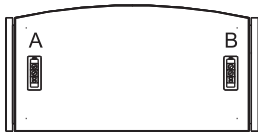

Mediaport:  
open / geöffnet / ouverte

\* Media port - there is an option to order desks with Mediaport:  
- slat S91E location A, B (1pc) or C (2pcs)  
- slat S92E location G, H (1pc) or K (2pcs)  
Marking chosen symbol in the end of the product index.: e.g. X01A.

\* Die Konferenztische und Schreibtische können mit Strom und Netzwerkanschlüssen „Mediaport“ ausgestattet werden. Diese können wie folgt positioniert werden:

- Leiste S91E: Lage A, B (1 Stück) oder C (2 Stück)
- Leiste S92E: Lage G, H (1 Stück) oder K (2 Stück)

Bitte am Ende der Artikelnummer die ausgewählte Option hinzufügen, z.B. X01A.

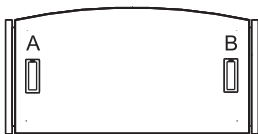

Mediaport:  
closed / geschlossen / fermée

\* Kit connectique - il est possible de commander les bureaux avec les mediabox:

- kit connectique S91E, option d'installation A, B (1 pc) ou C (2 pcs)
- kit connectique S92E, option d'installation G, H (1 pc) ou K (2 pcs)

Pour commander les mediabox veuillez mettre la référence à la fin du code de produit. p.ex.X01A.

**PEDESTAL / CONTAINER / CAISSONS**

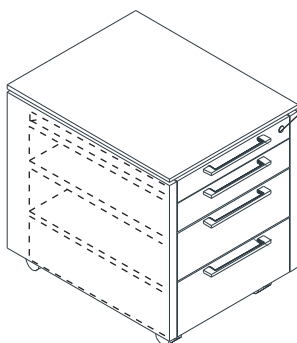

**Metal drawers  
Metallschublade  
Tiroirs en métal**

Drawers on roll runners , centrall lock with folded key and antitilt mechanism , (only one drawer may be opened at the same time) . Separate pencil drawer.

Rollenführungsschiene. Zentralverschluss mit Blockierung gegen das gleichzeitige Ausfahren von mehreren Schubladen, Klappschlüssel.

Caissons sont équipés des tiroirs en métal sur glissières à billes. Clé gainée articulée. Serrure centralisée, assure la fermeture de l'ensemble des tiroirs. Plumier séparé.

**Body  
Korpus  
Corps**

MFC / Melaminplatte /  
Panneau mélaminé  
18mm

**Top / Oberplatte / Top**

MFC / Melaminplatte /  
Panneau mélaminé  
12mm

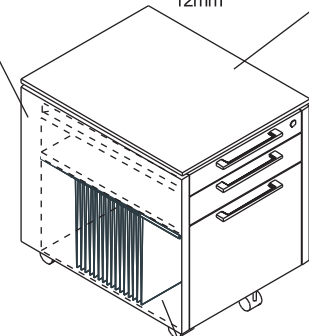

**Suspension file drawer / Aktenschublade / Tiroir pour DS.**

Extraction 100% / Vollauszug / Extraction 100%

**TECHNICAL SPECIFICATION / TECHNISCHE BESCHREIBUNG / DESCRIPTION TECHNIQUE**

**CABINETS / SCHRÄNKE / ARMOIRES**

**Top / Oberplatte / Top**

MFC / Melaminplatte /  
Panneau mélaminé  
12mm

**Side  
Seite  
Côté**

MFC / Melaminplatte /  
Panneau mélaminé  
28mm

**Body and kick plate  
Korpus und Sockel  
Corps et socle**

MFC / Melaminplatte /  
Panneau mélaminé  
18mm  
01 – anthracite  
anthrazit  
anthracite

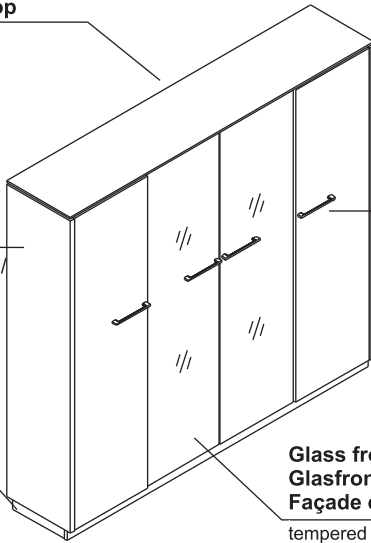

**Front / Front / Façade**

MFC / Melaminplatte /  
Panneau mélaminé  
18mm

**Glass front  
Glasfront  
Façade en verre**

tempered colourless glass  
Hartglas, farblos.  
verre trempé transparent  
5mm

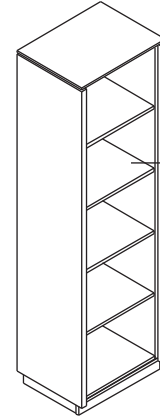

**Body and kick plate  
Korpus und Sockel  
Corps et socle**

MFC / Melaminplatte /  
Panneau mélaminé  
18mm  
01 – anthracite  
anthrazit  
anthracite

\* Cabinets do not have locks. There is a possibility of fixing two-point locks for an additional cost of 35 EUR per piece only in panel doors. In case of placing an extra order for the cabinet with lock "Z" symbol has to be added in the end product index. Every door wing must be equipped with the separate lock. There is no possibility of fixing a lock in a glass doors.

\* Ohne Verschluss. Zusätzlich gegen Aufpreis 35 EURO nur in Plattentüren möglich am Ende des Index "Z" angeben. Jede Flügeltür muss eine separate Verriegelung haben.

\* Armoires ne sont pas équipées d'une serrure. Montage d'une serrure simple pour un prix supplémentaire de 35 EUR après remise. Pour commander une serrure, veuillez mettre un "Z" à la fin du code de produit. Chaque battant de la porte doit être équipé d'une serrure séparée. Il n'est pas possible d'installer une serrure dans la porte vitrée.

**Column / Fuß / Pied**

powder-coated metal  
Metal pulverbeschichtet  
métal peint en poudre époxy  
ø100mm

**Disc base  
Untergestell  
Embase**

stainless steel  
Edelstahl  
acier inoxydable,  
ø620mm

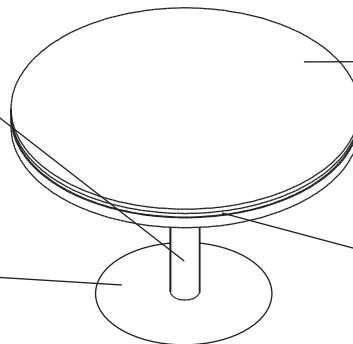

**Top  
Arbeitsplatte  
Plan de travail**

MFC / Melaminplatte /  
Panneau mélaminé  
52mm (12+12+28mm)

**Spacer  
Abstand  
Entretoise**



MFC / Melaminplatte /  
Panneau mélaminé  
12mm  
01 - anthracite  
Anthrazit  
anthracite

**FINISHES / FARBEN / FINITIONS**

31 CANADIAN OAK KANADISCHE EICHE CHENE CANADIEN	34 CHESTNUT WENGE WENGE	106 LOWLAND NUT NUSSBAUM PLAINE NOYER					
01 ANTHRACITE ANTHRAZIT ANTHRACITE	Spacer Abstand Entretoise						
08 BLACK SCHWARZ NOIR	09 ALUMINIUM ALUMINIUM ALUMINIUM	15 METAL, HIGH GLOSS WHITE METALL, WEIß GLANZ METAL, BLANC BRILLANT					
STAINLESS STEEL EDELSTAHL ACIER INOXYDABLE							

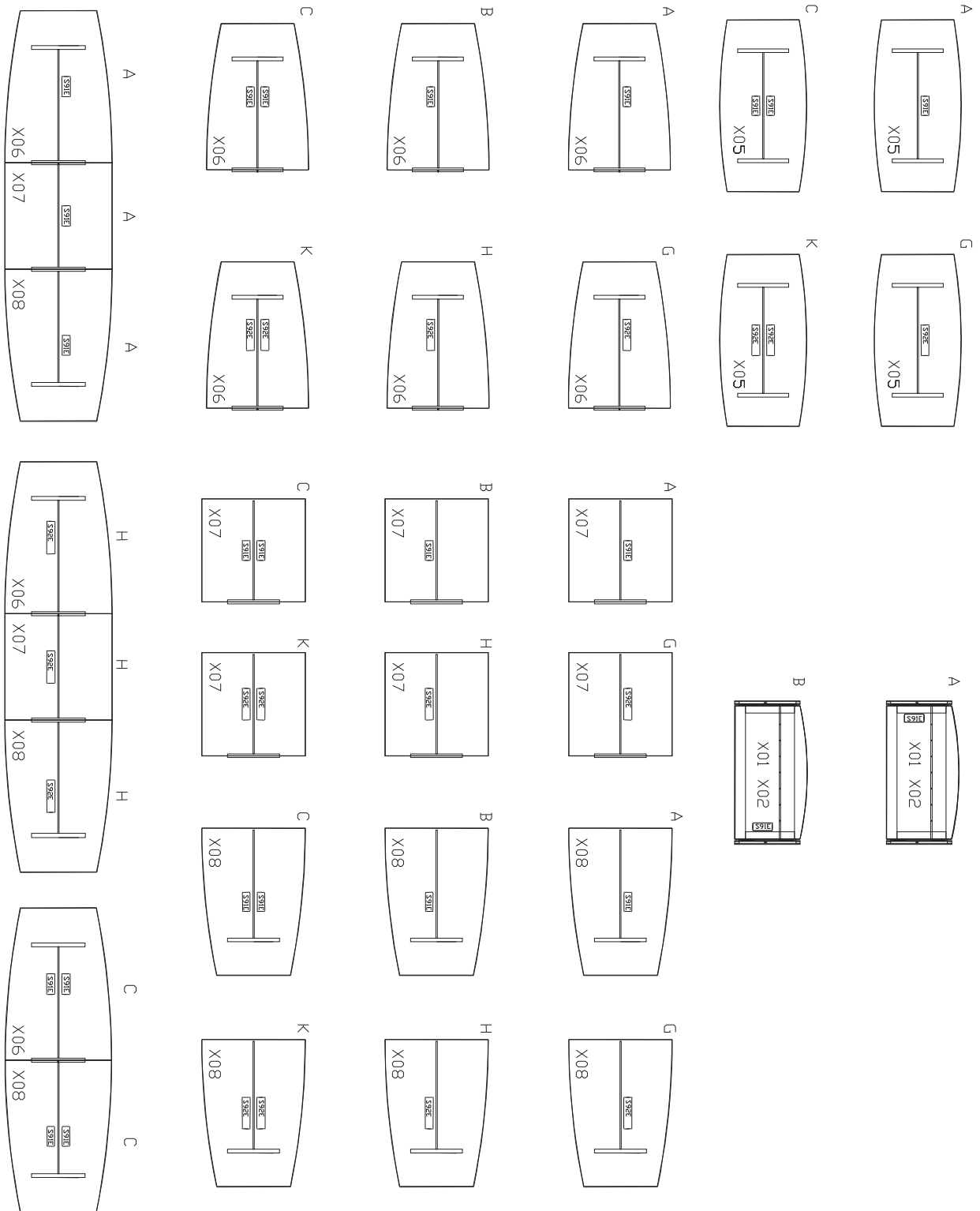
**MEDIA PORT LOCATION / PLAZIERUNG DES MEDIAPORTS / EMLACEMENT DE MEDIAPORTE**



PRODUCT ILLUSTRATION / PRODUKTANSICHT UND SKIZZE / VUE DE PRODUIT	DIMENSIONS / ABMESSUNGEN [mm]			INDEX SYMBOL					ECO	COMMENTS / BEMERKUNGEN / REMARQUES
	WIDTH / BREITE / LARGEUR	DEPTH / TIEFE / PROFONDEUR	HEIGHT / HÖHE / HAUTEUR							

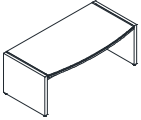
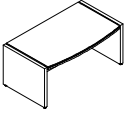

**DESKS / SCHREIBTISCHE / BUREAU**

	2000	1000	760	<b>X01</b>		172.0	0.501	4	16.856	- media port location A or B / Lage des Medienports - A bzw. B / - Kit connectique option A ou B, à commander séparément
	1700	970	760	<b>X02</b>		156.8	0.451	4	15.366	- media port location A or B / Lage des Medienports - A bzw. B / - Kit connectique option A ou B, à commander séparément



**DESK EXTENSION / ANSATZSTÜCKE FÜR SCHREIBTISCHE / EXTENSIONS**

	800	1200	760	<b>X14</b>		68.6	0.152	4	6.723	- front extension / vorderer Ansatzstück, Konferenztisch / - extension frontale pour table de réunion
	600	1270	760	<b>X15</b>		73.8	0.229	2	7.232	- right side extension / rechtes seitliches Ansatzstück / - extension latérale, droite
	600	1270	760	<b>X16</b>		74.0	0.229	2	7.252	- left side extension / linkes seitliches Ansatzstück / - extension latérale, gauche

**PEDESTALS / CONTAINER / CAISSONS**

	452	606	598	<b>XKD12</b>		35.4	0.183	1	3.929	- File drawer / Schublade für file drawer / - tiroir pour DS.
	452	606	598	<b>XKD13</b>		35.4	0.183	1	3.929	

**ADDITIONAL CHARGE / AUFFREIS FÜR SONDERAUSSTATTUNG / PLUS VALUE**

FEATURE / EIGENSCHAFT / ATTRIBUT	PRODUCT / SYMBOL / PRODUITS											COMMENTS / BEMERKUNGEN / REMARQUES
						XKD12	XKD13					
self closing system / Selbstschließsystem / fermeture silencieuse									1.0	0.0010	1	
Ball runners / Kugelführungen / Glissières à billes									1.0	0.0010	1	

DESCRIPTION / LEGENDE / LÉGENDE:

 net weight / Nettogewicht / poids net

 volume / Volumen / le volume

 number of packages / Stückzahl der Pakete / nombre de colis

PRODUCT ILLUSTRATION / PRODUKTANSICHT UND SKIZZE / VUE DE PRODUIT	DIMENSIONS / ABMESSUNGEN [mm]			INDEX SYMBOL					ECO	COMMENTS / BEMERKUNGEN / REMARQUES
	WIDTH / BREITE / LARGEUR	DEPTH / TIEFE / PROFONDEUR	HEIGHT / HÖHE / HAUTEUR			kg	m <sup>3</sup>	pcs	EUR	

**5H STORAGE / SCHRÄNKE UND REGALE 50H / ARMOIRES ET RANGEMENTS 50H**

	544	421	1876	<b>X56</b>		119.4	0.283	4	13.253	- left door / linke Tür / - porte gauche
	544	421	1876	<b>X57</b>		119.4	0.283	4	13.253	- right door / rechte Tür / - porte droite
	544	421	1876	<b>X59</b>		108.9	0.260	4	12.088	
	1032	421	1876	<b>X51</b>		167.9	0.386	5	18.631	
	1032	421	1876	<b>X52</b>		157.6	0.368	5	17.488	- wardrobe storage cabinet with slide out hanger / Kleider- und Aktenschrank mit ausfahbarem Kleiderbügel / - penderie avec dossiers suspendus
	1032	421	1876	<b>X55</b>		219.5	0.404	5	24.359	- transparent tempered glass doors / Glasür, durchsichtiges Sicherheitsglas / - porte vitrée, verre trempé transparent
	1520	421	1876	<b>X5679</b>		225.5	0.519	6	25.031	
	2008	421	1876	<b>X5567</b>		336.9	0.668	7	37.396	- transparent tempered glass doors / Glasür, durchsichtiges Sicherheitsglas / porte vitrée, verre trempé transparent

DESCRIPTION / LEGENDE / LÉGENDE:

net weight / Nettogewicht / poids net

volume / Volumen / le volume

number of packages / Stückzahl der Pakete / nombre de colis

PRODUCT ILLUSTRATION / PRODUKTANSICHT UND SKIZZE / VUE DE PRODUIT	DIMENSIONS / ABMESSUNGEN [mm]			INDEX SYMBOL					ECO	COMMENTS / BEMERKUNGEN / REMARQUES
	WIDTH / BREITE / LARGEUR	DEPTH / TIEFE / PROFONDEUR	HEIGHT / HÖHE / HAUTEUR			kg	m <sup>3</sup>	pcs	EUR	

**5H STORAGE / SCHRÄNKE UND REGALE 50H / ARMOIRES ET RANGEMENTS 50H**

	2496	421	1876	<b>X5119</b>		324.2	0.738	8	35.986	
	2496	421	1876	<b>X5129</b>		313.9	0.719	8	34.843	- on the right side wardrobe withslide out hanger / enthält einen Garderobenelement / comprend une penderie

**3H STORAGE / SCHRÄNKE UND REGALE 30H / ARMOIRES ET RANGEMENTS 3 OH**



	544	421	1167	<b>X36</b>		79.1	0.176	4	8.780	- left door / linke Tür / porte gauche
	544	421	1167	<b>X37</b>		79.1	0.176	4	8.780	- right door / rechte Tür / porte droite
	544	421	1167	<b>X39</b>		72.8	0.169	4	8.081	
	1032	421	1167	<b>X31</b>		111.7	0.255	4	12.393	
	1032	421	1167	<b>X35</b>		114.7	0.284	5	12.726	- transparent,tempered glass doors / Glastür, durchsichtiges Sicherheitsglas / porte vitrée, verre trempé transparent
	2008	421	1167	<b>X311</b>		185.4	0.425	5	20.579	
	1520	421	1167	<b>X3679</b>		151.6	0.331	6	16.828	

DESCRIPTION / LEGENDE / LÉGENDE:



net weight / Nettogewicht / poids net

volume / Volumen / le volume





number of packages / Stückzahl der Pakete / nombre de colis

PRODUCT ILLUSTRATION / PRODUKTANSICHT UND SKIZZE / VUE DE PRODUIT	DIMENSIONS / ABMESSUNGEN [mm]			INDEX SYMBOL					ECO	COMMENTS / BEMERKUNGEN / REMARQUES
	WIDTH / BREITE / LARGEUR	DEPTH / TIEFE / PROFONDEUR	HEIGHT / HÖHE / HAUTEUR			kg	m <sup>3</sup>	pcs	EUR	

**3H STORAGE / SCHRÄNKE UND REGALE 3OH / ARMOIRES ET RANGEMENTS 3 OH**

	2008	421	1167	<b>X3567</b>		194.3	0.451	7	21.567	- transparent, tempered glass doors / Glasür, durchsichtiges Sicherheitsglas / porte vitrée, verre trempé transparent
	2496	421	1167	<b>X3119</b>		218.5	0.499	6	24.253	

**2H STORAGES / SCHRÄNKE UND REGALE 2OH / ARMOIRES ET RANGEMENTS 2OH**

	544	421	820	<b>X26</b>		57.0	0.146	4	6.327	
	544	421	820	<b>X27</b>		57.0	0.146	4	6.327	
	1032	421	820	<b>X21</b>		80.9	0.192	4	8.974	
	2008	421	820	<b>X2167</b>		140.7	0.358	6	15.618	

DESCRIPTION / LEGENDE / LÉGENDE:

 net weight / Nettogewicht / poids net

 volume / Volumen / le volume

 number of packages / Stückzahl der Pakete / nombre de colis

PRODUCT ILLUSTRATION / PRODUKTANSICHT UND SKIZZE / VUE DE PRODUIT	DIMENSIONS / ABMESSUNGEN [mm]			INDEX SYMBOL					ECO	COMMENTS / BEMERKUNGEN / REMARQUES
	WIDTH / BREITE / LARGEUR	DEPTH / TIEFE / PROFONDEUR	HEIGHT / HÖHE / HAUTEUR							

**TABLES AND COFFEE TABLES / TISCHE UND KLEINE TISCHE / TABLES ET TABLES BASSES**

	2400	1200	760	<b>X05</b>		232.0	0.561	4	22.736	media port location A, G(2pcs.) or C,K(2pcs) / Lage des Mediaports A,G (2 Stck.) oder C,K (2 Stck.) / emplacement du mediaport A(1pcs.), C(2pcs) lub G(1 pcs),K(2pcs.)
	2000	1400	760	<b>X06</b>		227.1	0.554	4	22.256	conference table-media port location A,B,G,H (1pcs) or C,K (2pcs) / Anfangstelement des Konferenztisches - Lage des Mediaports A,B,G,H (1 Stk.) oder C,K (2 Stck.) / élément de départ de table de conférence,
	1400	1400	760	<b>X07</b>		179.2	0.364	4	17.562	-middle part of conference table-media port location A, B,G,H (1pcs) or C,K (2pcs) / Anfangstelement des Konferenztisches - Lage des Mediaports A, B,G,H (1 Stck.) oder C, K (2 Stck.) / élément
	2000	1400	760	<b>X08</b>		200.2	0.492	4	19.620	- ending part of conferencetable -media port location A,B,G,H (1pcs) or C,K (2pcs) / Endelement - Lage des Mediaports A,B,G,H (1 Stck.) oder C,K (2 Stck.) / élément final de la table de réunion - emplacement du mediaport
	800	800	550	<b>X19</b>		76.9	0.144	2	7.536	
	800	800	760	<b>X22</b>		92.0	0.223	2	9.016	
	1200	1200	756	<b>X120</b>		43.0	0.384	2	4.214	

**ACCESSORIES / ZUBEHÖR / ACCESSOIRES**

	267	110	93	<b>S91E</b>		1.0	0.010	1	0.098	- 2 x 230V- 2 x RJ45 / 2 x 230V- 2 x RJ45
	426	110	93	<b>S92E</b>		1.0	0.014	1	0.098	- 4 x 230V- 4 x RJ45 / 4 x 230V, 4 x RJ45 / 4 x 230V- 4 x RJ45

DESCRIPTION / LEGENDE / LÉGENDE:

net weight / Nettogewicht / poids net

volume / Volumen / le volume

number of packages / Stückzahl der Pakete / nombre de colis